

100.1210 Mod. 1200P-MS $\frac{1}{2}$ "", 100.1213 Mod. 1200P-MS $\frac{3}{4}$ "

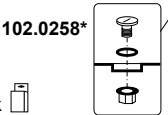

102.1425*

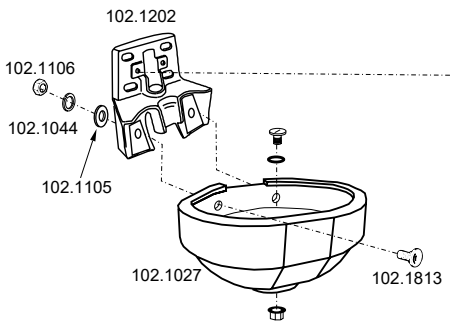
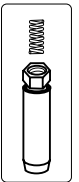

$\frac{1}{2}$ " = 102.1203
 $\frac{3}{4}$ " = 102.1573

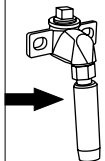
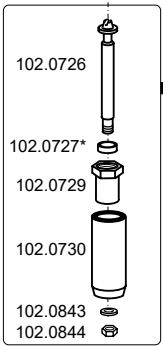
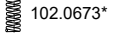
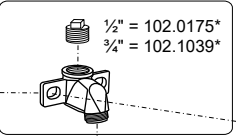

$\frac{1}{2}$ " = 102.1204
 $\frac{3}{4}$ " = 102.1574

- * Multipack 
- 102.0175-5
 - 102.0258-2
 - 102.0673-10
 - 102.0727-10
 - 102.1039-5
 - 102.1425-1